

INSPIRON™

SETUP GUIDE



INSPIRON™

SETUP GUIDE

Model P04S series

Regulatory type: P04S001

Notes, Cautions, and Warnings



NOTE: A NOTE indicates important information that helps you make better use of your computer.



CAUTION: A CAUTION indicates either potential damage to hardware or loss of data and tells you how to avoid the problem.



WARNING: A WARNING indicates a potential for property damage, personal injury, or death.

If you purchased a Dell™ n Series computer, any references in this document to Microsoft® Windows® operating systems are not applicable.

Information in this document is subject to change without notice.

© 2009 Dell Inc. All rights reserved.

Reproduction of these materials in any manner whatsoever without the written permission of Dell Inc. is strictly forbidden.

Trademarks used in this text: *Dell*, the *DELL* logo, *Inspiron*, *YOURS IS HERE*, *Dell On Call*, and *DellConnect* are trademarks of Dell Inc.; *ATI Radeon* is a trademark of Advanced Micro Devices, Inc; *Intel*, *Celeron*, and *Pentium* are registered trademarks and *Core* is a trademark of Intel Corporation in the U.S. and other countries; *Microsoft*, *Windows*, *Windows Vista*, and *Windows Vista* start button logo are either trademarks or registered trademarks of Microsoft Corporation in the United States and/or other countries.; *Bluetooth* is a registered trademark owned by Bluetooth SIG, Inc. and is used by Dell under license; *SRS Premium Sound*, *SRS*, and the  symbol are trademarks of SRS Labs, Inc.

Other trademarks and trade names may be used in this document to refer to either the entities claiming the marks and names or their products. Dell Inc. disclaims any proprietary interest in trademarks and trade names other than its own.

Contents

Setting Up Your Inspiron™ Laptop	5	Solving Problems	29
Before Setting Up Your Computer	5	Beep Codes	29
Connect the AC Adapter	6	Network Problems	31
Connect the Network Cable (Optional)	7	Power Problems	32
Press the Power Button	8	Memory Problems	34
Set Up Microsoft® Windows Vista®	9	Lockups and Software Problems	35
Enable or Disable Wireless (Optional)	10	Using Support Tools	37
Connect to the Internet (Optional)	12	Dell Support Center	37
Using Your Inspiron Laptop	14	System Messages	38
Right Side Features	14	Hardware Troubleshooter	40
Left Side Features	16	Dell Diagnostics	40
Computer Base Features	18	Restoring Your Operating System	43
Media Controls	21	System Restore	44
Display Features	22	Dell Factory Image Restore	45
Removing and Replacing the Battery	24	Operating System Reinstallation	47
Software Features	26		

Contents

Getting Help	49
Technical Support and Customer Service	50
DellConnect™	50
Online Services	51
Automated Order-Status Service	52
Product Information	52
Returning Items for Repair Under Warranty or for Credit	53
Before You Call	54
Contacting Dell	55
Finding More Information and Resources	56
Specifications	58
Appendix	67
Macrovision Product Notice	67
Index	68

Setting Up Your Inspiron™ Laptop

This section provides information about setting up your Inspiron 1320 laptop.

Before Setting Up Your Computer

When positioning your computer, ensure that you allow easy access to a power source, adequate ventilation, and a level surface to place your computer.

Restricting airflow around your Inspiron laptop may cause it to overheat. To prevent overheating ensure that you leave at least 10.2 cm (4 inches) at the back of the computer and a minimum of 5.1 cm (2 inches) on all other sides. You should never place your computer in an enclosed space, such as a cabinet or drawer when it is powered on.

 **WARNING:** Do not block, push objects into, or allow dust to accumulate in the air vents. Do not store your Dell™ computer in a low-airflow environment, such as a closed briefcase, while it is powered on. Restricting the airflow can damage the computer or cause a fire. The computer turns on the fan when the computer gets hot. Fan noise is normal and does not indicate a problem with the fan or the computer.

 **CAUTION:** Placing or stacking heavy or sharp objects on the computer may result in permanent damage to the computer.

Connect the AC Adapter

Connect the AC adapter to the computer and then plug the other end to an electrical outlet or surge protector.

⚠ WARNING: The AC adapter works with electrical outlets worldwide. However, power connectors and power strips vary among countries. Using an incompatible cable or improperly connecting the cable to a power strip or electrical outlet may cause fire or permanent damage to your computer.

🔧 NOTE: Use only Dell AC adapter family PA-12, PA-2E, and PA-3E with your computer.

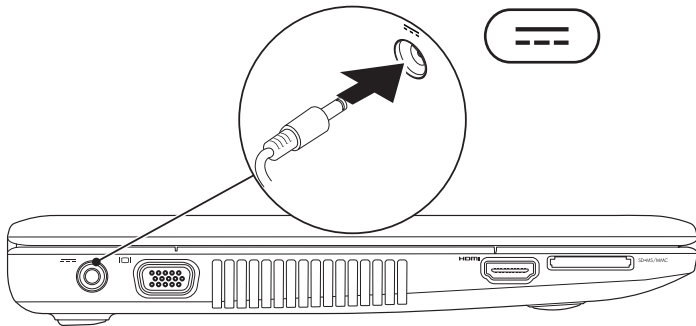

Connect the Network Cable (Optional)

To use a wired network connection, connect the network cable.

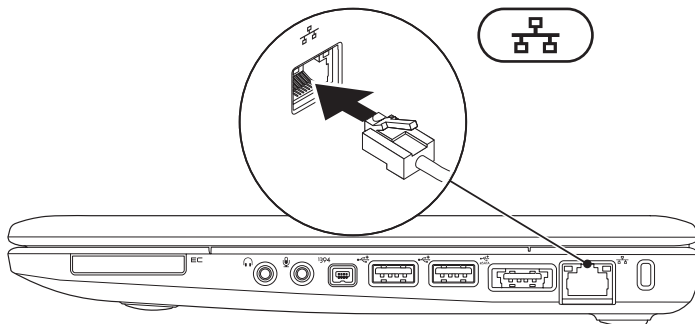

Press the Power Button

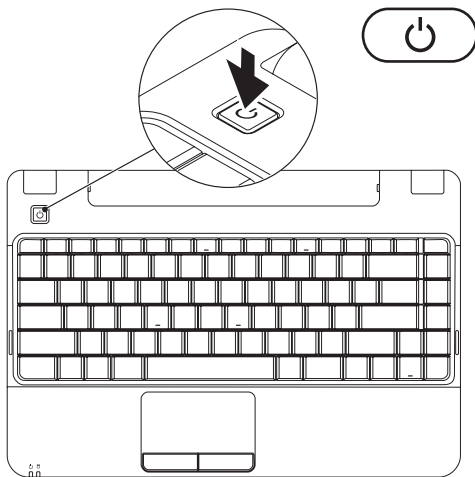



Set Up Microsoft® Windows Vista®

Your computer is preconfigured with Windows Vista operating system if you ordered it while purchasing your computer. To set up Windows Vista for the first time, follow the instructions on the screen. These steps are mandatory and may take up to 15 minutes to complete. The Windows Vista setup screen will take you through several procedures including accepting license agreements, setting preferences, and setting up an Internet connection.

 **CAUTION: Do not interrupt the operating system's setup process. Doing so may render your computer unusable and you will need to reinstall the operating system.**

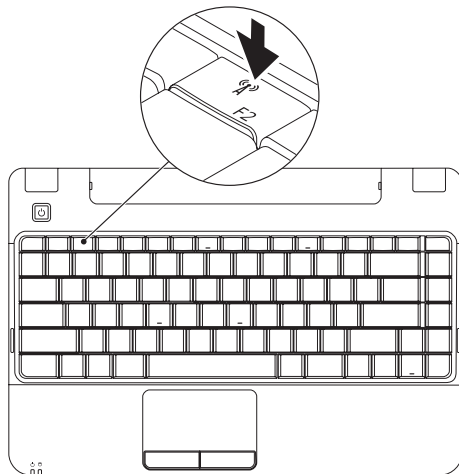
Enable or Disable Wireless (Optional)



1. Press the <F2> key or press the  key on the keyboard to enable or disable wireless. The wireless enable or disable dialog box will appear on your screen.

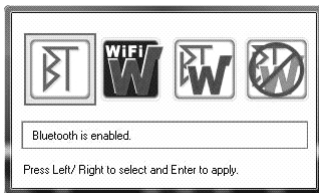

2. Press the left-arrow key or the right-arrow keys to:
 - Enable Bluetooth
 - Enable Wireless LAN
 - Enable Bluetooth and Wireless LAN
 - Disable Bluetooth and Wireless LAN
3. Press <Enter> to apply the change.

Connect to the Internet (Optional)

To connect to the Internet, you need an external modem or network connection and an Internet service provider (ISP).

If an external USB modem or WLAN adapter is not a part of your original order, you can purchase one from the Dell website at www.dell.com.

You can connect to the Internet using either a wired or a wireless connection.

Setting Up a Wired Connection

- If you are using a dial-up connection, connect the telephone line to the external USB modem (optional) and to the telephone wall connector before you set up your Internet connection.

- If you are using a DSL or cable/satellite modem connection, contact your ISP or cellular telephone service for setup instructions

Setting Up a Wireless Connection

Before you can use your wireless Internet connection, you need to connect to your wireless router.

1. Ensure that wireless is enabled on your computer (see “Enable or Disable Wireless” on page 10).
2. Save and close any open files, and exit any open programs.
3. Click **Start**  → **Connect To**.
4. Follow the instructions on the screen to complete the setup.

Setting Up Your Internet Connection

ISPs and ISP offerings vary by country. Contact your ISP for offerings available in your country.

If you cannot connect to the Internet but have successfully connected in the past, the ISP might have a service outage. Contact your ISP to check the service status, or try connecting again later.

Have your ISP information ready. If you do not have an ISP, the **Connect to the Internet** wizard can help you get one.

1. Save and close any open files, and exit any open programs.

 **NOTE:** The following instructions are applicable for the Windows default view, they may not apply if you set your computer to the Windows Classic view.

2. Click **Start**  → **Control Panel**.

3. Click **Network and Internet** → **Network and Sharing Center** → **Setup a Connection** → **Connect to the Internet**.

The **Connect to the Internet** window appears.

-  **NOTE:** If you do not know which type of connection to select, click **Help me choose** or contact your ISP.
4. Follow the instructions on the screen and use the setup information provided by your ISP to complete the setup.

Using Your Inspiron Laptop





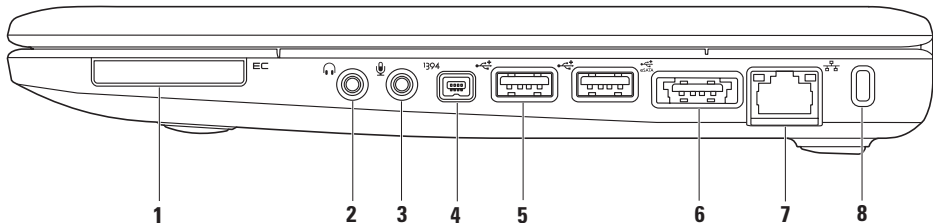

Your Inspiron 1320 laptop has indicators and buttons that provide information and enable you to perform common tasks. The connectors on your computer provide the option of attaching additional devices.

Right Side Features



- 1**  **ExpressCard slot** – Supports one ExpressCard. The computer ships with a plastic blank installed in the slot.

NOTE: Your computer ships with a plastic blank installed in the ExpressCard slot. Blanks protect unused slots from dust and other particles. Save the blank for use when no ExpressCard is installed in the slot; blanks from other computers may not fit your computer.

-
- 2  **Audio out/Headphone connector** – Connects to a pair of headphones, or sends audio to a powered speaker or sound system.
-
- 3  **Audio in/Microphone connector** – Connects to a microphone or inputs signal for use with audio programs.
-
- 4  **IEEE 1394 connector** – Connects to high-speed serial multimedia devices, such as digital video cameras.
-
- 5  **USB 2.0 connectors (2)** – Connects to USB devices, such as a mouse, keyboard, printer, external drive, or MP3 player.
-
- 6  **eSATA/USB combo connector** – Connects to eSATA compatible storage devices (such as external hard disk drives or optical drives) or USB devices (such as a mouse, keyboard, printer, external drive, or MP3 player).
-
- 7  **Network connector** – Connects your computer to a network or a broadband device if you are using a wired network.
-
- 8 **Security cable slot** – Attaches a commercially available antitheft device to the computer.
NOTE: Before you buy an antitheft device, ensure that it works with the security cable slot on your computer.
-

Left Side Features

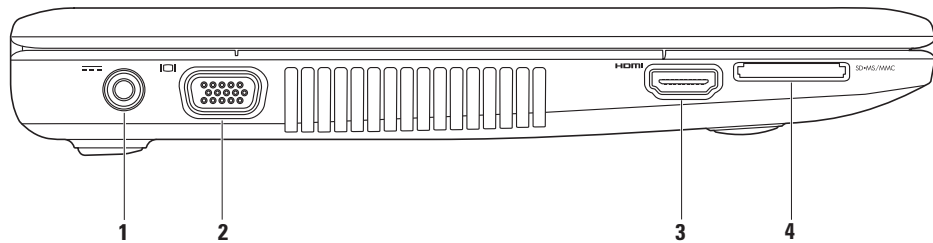

1  **AC adapter connector** – Connects to the AC adapter to power the computer and charge the battery.

2  **VGA connector** – Connects to a monitor or projector.

3  **HDMI connector** – Connects to a TV for both 5.1 audio and video signals.
NOTE: When used with a monitor, only the video signal is read.

4  **5-in-1 Media Card Reader** – Provides a fast and convenient way to view and share digital photos, music, videos, and documents stored on the following digital memory cards:

- Secure Digital (SD) memory card
- Secure Digital High Capacity (SDHC) card
- Multimedia Card (MMC)
- Memory Stick
- Memory Stick PRO

NOTE: Your computer ships with a plastic blank installed in the Media Card Reader slot. Blanks protect unused slots from dust and other particles. Save the blank for use when no Media card is installed in the slot; blanks from other computers may not fit your computer.

Computer Base Features

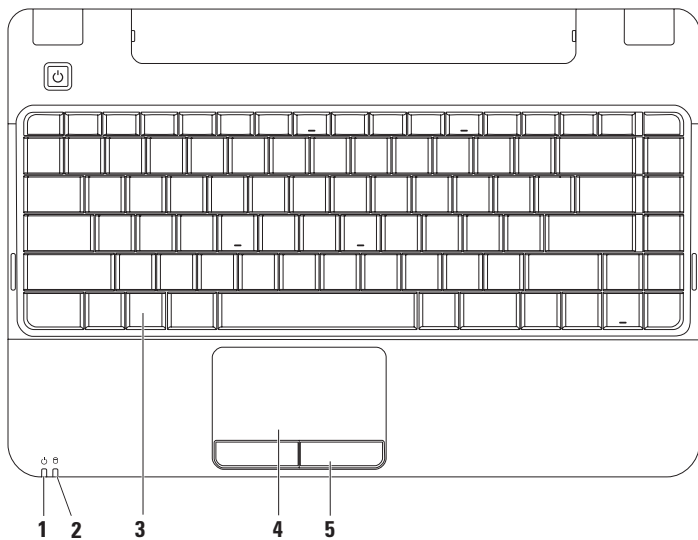

- 1  **Power/Battery indicator light** – The light indicates the following states when powered using an AC adapter or a battery.

	Indicator light status	Computer state(s)	Battery charge level
AC Adapter	Solid white	on off/hibernate	n/a <90%
	Breathing white	standby	n/a
	off	off/hibernate	>90%
Battery	Solid white	on	>10%
	Breathing white	standby	>10%
	Solid amber	on/standby	<10%
	off	off/hibernate	n/a

NOTE: The battery is charging when the computer is powered using an AC adapter.

- 2**  **Hard drive activity light** – Turns on when the computer reads or writes data. A blinking light indicates hard drive activity.

NOTE: To avoid loss of data, never turn off the computer while the hard drive activity light is flashing.

- 3 Keyboard** – The media controls are also located on the keyboard. These keys control CD, DVD, and media playback. For more information about the keyboard, see the *Dell Technology Guide* on your hard drive or on the Dell Support website at support.dell.com.
-

- 4 Touch pad** – Provides the functionality of a mouse to move the cursor, drag or move selected items, and left-click by tapping the surface.
-

- 5 Touch pad buttons** – Provide left- and right-click functions like those on a mouse.
-

Media Controls

The media control keys are located on the keyboard.

To use the media controls, press the required key. You can use the **Function Key Behavior** setting in the **System Setup** (BIOS) utility to configure the media control keys.

The options in the **Function Key Behavior** setting are:

Multimedia Key First – This is the default option. Press any multimedia key to perform the associated action. For function key, press <Fn> + the required function key.

Function Key First – Press any function key to perform the associated action. For multimedia key, press <Fn> + the required multimedia key.



 Mute the sound

 Decrease the volume level

 Increase the volume level

 Play the previous track or chapter

 Play or pause

 Play the next track or chapter

 Eject the disc from optional USB/eSATA optical drive

Display Features

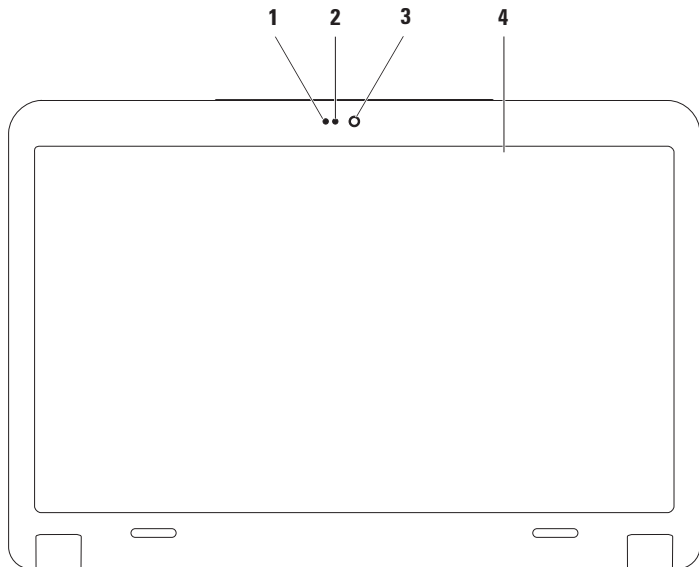



1 Microphone – Provides quality sound for audio chatting and voice recording.

2 Camera activity light – Indicates if the camera is on or off.

3 Camera – Built-in camera for video capture, conferencing, and chat.

4 Display – Your display can vary based on selections you made when purchasing your computer. For more information about displays, see the *Dell Technology Guide* on your hard drive or on the Dell Support website at support.dell.com.

Removing and Replacing the Battery

-  **WARNING:** Before you begin any of the procedures in this section, follow the safety instructions that shipped with your computer.
-  **WARNING:** Using an incompatible battery may increase the risk of fire or explosion. This computer should only use a battery purchased from Dell. Do not use batteries from other computers.
-  **WARNING:** Before removing the battery, shut down the computer, and remove external cables (including the AC adapter).

To remove the battery:

1. Shut down the computer and turn it over.
2. Slide the battery release latch to the unlock position.
3. Slide the battery out and lift it.

To replace the battery:

1. Align the battery with the notch on both sides and place it in the battery bay.
2. Push the battery until it clicks into place.

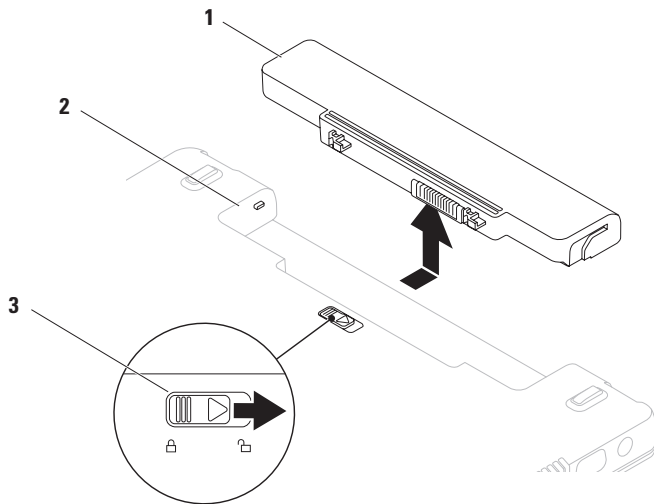

1 battery

2 battery bay

3 battery release latch

Software Features

 **NOTE:** For more information about the features described in this section, see the *Dell Technology Guide* on your hard drive or on the Dell Support website at support.dell.com.

Productivity and Communication

You can use your computer to create presentations, brochures, greeting cards, fliers, and spreadsheets. You can also edit and view digital photographs and images. Check your purchase order for software installed on your computer.

After connecting to the Internet, you can access websites, setup an e-mail account, upload and download files, and so on.

Entertainment and Multimedia

You can use your computer to watch videos, play games, create your own CDs/DVDs, listen to music and Internet radio stations.

 **NOTE:** Your computer does not have an internal optical drive. Use an external optical drive or any external storage device for the procedures that involve discs.

You can download or copy pictures and video files from portable devices, such as digital cameras and cell phones. Optional software applications enable you to organize and create music and video files that can be recorded to disc, saved on portable products such as MP3 players and handheld entertainment devices, or played and viewed directly on connected TVs, projectors, and home theater equipment.

Customizing the Desktop

You can customize your desktop to change the appearance, resolution, wallpaper, screensaver, and so on by accessing the **Personalize appearance and sounds** window.

To access the **Display Properties** window:

1. Right-click an open area of the desktop.
2. Click **Personalize**, to open the **Personalize appearance and sounds** window and learn more about your customization options.

Customizing Your Energy Settings

You can use the power options in your operating system to configure the power settings on your computer. Microsoft® Windows Vista® installed on your Dell computer provides three default options:

- **Dell Recommended** — This power option offers full performance when you need it and saves power during periods of inactivity.
- **Power saver** — This power option saves power on your computer by reducing system performance to maximize the life of the computer and by reducing the amount of energy consumed by your computer over its lifetime.
- **High performance** — This power option provides the highest level of system performance on your computer by adapting processor speed to your activity and by maximizing system performance.

Transferring Information to a New Computer

1. Click **Start**  → **Control Panel** → **System and Maintenance** → **Welcome Center** → **Transfer files and settings**.

If the **User Account Control** window appears, click **Continue**.

2. Follow the instructions in the **Windows Easy Transfer** wizard.

Backing Up Your Data

It is recommended that you periodically back up files and folders on your computer. To back up files:

1. Click **Start**  → **Control Panel** → **System and Maintenance** → **Backup and Restore Center** → **Backup Files**.

If the **User Account Control** window appears, click **Continue**.

 **NOTE:** Certain editions of Windows Vista provide an option to back up your computer.

2. Follow the instructions in the **Back Up Files** wizard.

Solving Problems

This section provides troubleshooting information for your computer. If you cannot solve your problem using the following guidelines, see “Using Support Tools” on page 37 or “Contacting Dell” on page 55.

 **WARNING: Only trained service personnel should remove the computer cover. See the *Service Manual* on the Dell Support website at support.dell.com for advanced service instructions.**

Beep Codes

Your computer might emit a series of beeps during start-up if the monitor cannot display errors or problems. The following repetitive beep codes help you troubleshoot problems with your computer.

 **NOTE:** To replace parts, see the *Service Manual* on the Dell Support website at support.dell.com.

One beep — *Possible motherboard failure - BIOS ROM checksum failure*

Contact Dell (see “Contacting Dell” on page 55).

Solving Problems

Two beeps — *No RAM detected*

- Remove the memory modules, reinstall one module and restart the computer. If the computer starts normally, reinstall an additional module. Continue until you have identified a faulty module or reinstalled all modules without an error.
- If available, install memory modules of the same type in your computer.
- If the problem persists, contact Dell (see “Contacting Dell” on page 55).

Three beeps — *Possible motherboard failure - Chipset error*

Contact Dell (see “Contacting Dell” on page 55).

Four beeps — *RAM read/write failure*

- Ensure that no special memory module/memory connector placement requirements exist (see the *Service Manual* on the Dell Support website at support.dell.com).

- Verify that the memory modules that you are installing are compatible with your computer. For more information about the type of memory supported by your computer, see “Specifications” on page 58.
- If the problem persists, contact Dell (see “Contacting Dell” on page 55).

Five beeps — *Real Time Clock failure*

Replace the battery.

Six beeps — *Video card or chip failure*

Contact Dell (see “Contacting Dell” on page 55).

Seven beeps — *Processor failure*

Contact Dell (see “Contacting Dell” on page 55).

Eight beeps — *Display failure*

Contact Dell (see “Contacting Dell” on page 55).

Network Problems

Wireless Connections

If the wireless network connection is lost —

The wireless router is offline or wireless has been disabled on the computer.

- Check your wireless router to ensure it is powered on and connected to your data source (cable modem or network hub).
- Interference may be blocking or interrupting your wireless connection. Try moving the computer closer to your wireless router.
- Re-establish your connection to the wireless router:
 - a. Ensure that wireless is enabled on your computer (see “Enabling or Disabling Wireless” on page 10).
 - b. Click **Start**  → **Connect To**.
 - c. Follow the instructions on the screen to complete the setup.

Wired Connections

If the network connection is lost — The cable is loose or damaged.

- Check the cable to ensure it is plugged in and not damaged.

The link integrity light on the integrated network connector lets you verify that your connection is working and provides information on the status:

- Green — A good connection exists between a 10-Mbps network and the computer.
- Orange — A good connection exists between a 100/1000-Mbps network and the computer.
- Off — The computer is not detecting a physical connection to the network.

 **NOTE:** The link integrity light on the network connector is only for the wired cable connection. The link integrity light does not provide status for wireless connections.

Power Problems

If the power light is off — The computer is either turned off, in hibernate state or is not receiving power.

- Reseat the power cable into both the power connector on the computer and the electrical outlet.
- If the computer is plugged into a power strip, ensure that the power strip is plugged into an electrical outlet and that the power strip is turned on. Also bypass power protection devices, power strips, and power extension cables to verify that the computer turns on properly.
- Ensure that the electrical outlet is working by testing it with another device, such as a lamp.
- Check the AC adapter cable connections. If the AC adapter has a light, ensure that the light on the AC adapter is on.

If the power light is solid white and the computer is not responding — The computer is either turned off, in hibernate state or the display may not be responding.

- Press the power button. The computer resumes normal operation if it is off or in hibernate mode.
- If the display is not responding, press the power button until the computer turns off and then turn it back on.
- If the problem persists, contact Dell (see “Contacting Dell” on page 55 for assistance).

If the power light is solid amber and the computer is not responding — The computer is in standby mode with low battery or the display may not be responding.

- Connect the AC adapter to power the computer and charge the battery.

- Move the connected mouse or a finger on the touch pad or press the power button to resume normal operation.
- If the display is not responding, press the power button until the computer turns off and then turn it back on.
- If the problem persists, contact Dell (see “Contacting Dell” on page 55 for assistance).

If the power light is breathing white and the computer is not responding — The computer is in standby mode or the display may not be responding.

- Move the connected mouse or a finger on the touch pad or press the power button to resume normal operation.
- If the display is not responding, press the power button until the computer turns off and then turn it back on.

- If the problem persists, contact Dell (see “Contacting Dell” on page 55 for assistance).

If you encounter interference that hinders reception on your computer — An unwanted signal is creating interference by interrupting or blocking other signals. Some possible causes of interference are:

- Power, keyboard, and mouse extension cables.
- Too many devices connected to a power strip.
- Multiple power strips connected to the same electrical outlet.

Memory Problems

If you receive an insufficient memory message —

- Save and close any open files and exit any open programs you are not using to see if that resolves the problem.
- See the software documentation for minimum memory requirements. If necessary, install additional memory (see the *Service Manual* on the Dell Support website at support.dell.com).
- Reseat the memory modules (see the *Service Manual* on the Dell Support website at support.dell.com) to ensure that your computer is successfully communicating with the memory.

If you experience other memory problems —

- Ensure that you are following the memory installation guidelines (see the *Service Manual* on the Dell Support website at support.dell.com).
- Check if the memory module is compatible with your computer. Your computer supports DDR2 memory. For more information about the type of memory supported by your computer, see “Specifications” on page 58.
- Run the Dell Diagnostics (see “Dell Diagnostics” on page 40).
- Reseat the memory modules (see the *Service Manual* on the Dell Support website at support.dell.com) to ensure that your computer is successfully communicating with the memory.

Lockups and Software Problems

If the computer does not start up — Ensure that the power cable is firmly connected to the computer and to the electrical outlet.

If a program stops responding —
End the program:

1. Press <Ctrl><Shift><Esc> simultaneously.
2. Click **Applications**.
3. Select the program that is no longer responding.
4. Click **End Task**.

If a program crashes repeatedly — Check the software documentation. If necessary, uninstall and then reinstall the program.

 **NOTE:** Software usually includes installation instructions in its documentation or on the CD.

 **NOTE:** Your computer does not have an internal optical drive. Use an external optical drive or any external storage device for the procedures that involve discs.

If the computer stops responding or a solid blue screen appears —

 **WARNING:** You might lose data if you are unable to perform an operating system shutdown.

If you are unable to get a response by pressing a key on your keyboard or moving your mouse, press the power button for at least 8 to 10 seconds until the computer turns off and then restart your computer.

Solving Problems

If a program is designed for an earlier Microsoft® Windows® operating system —

Run the **Program Compatibility Wizard**. The Program Compatibility Wizard configures a program so that it runs in an environment similar to non-Windows Vista operating system environments.

1. Click **Start**  → **Control Panel** → **Programs** → **Use an older program with this version of Windows**.
2. In the welcome screen, click **Next**.
3. Follow the instructions on the screen.

If you have other software problems —

- Back up your files immediately.
- Use a virus-scanning program to check the hard drive or CDs.
- Save and close any open files or programs and shut down your computer through the **Start**  menu.

- Check the software documentation or contact the software manufacturer for troubleshooting information:
 - Ensure that the program is compatible with the operating system installed on your computer.
 - Ensure that your computer meets the minimum hardware requirements needed to run the software. See the software documentation for information.
 - Ensure that the program is installed and configured properly.
 - Verify that the device drivers do not conflict with the program.
 - If necessary, uninstall and then reinstall the program.

Using Support Tools

Dell Support Center

The Dell Support Center helps you find the service, support, and system-specific information you need.



Click the  icon in the taskbar to run the application. The home page provides links to access:

- Self Help (Troubleshooting, Security, System Performance, Network/Internet, Backup/Recovery, and Windows Vista)
- Alerts (technical support alerts relevant to your computer)

- Assistance from Dell (Technical Support with DellConnect™, Customer Service, Training and Tutorials, How-To Help with Dell on Call, and Online Scan with PC CheckUp)
- About Your System (System Documentation, Warranty Information, System Information, Upgrades & Accessories)

The top of the Dell Support Center home page displays your system's model number along with its service tag and express service code.

For more information about the Dell Support Center and available support tools, click the **Services** tab on support.dell.com.

System Messages

If your computer has an issue or an error, it may display a System Message that will help you identify the cause and action needed to resolve the issue.

 **NOTE:** If the message you received is not listed in the following examples, see the documentation for either the operating system or the program that was running when the message appeared. Alternatively you could see the *Dell Technology Guide* on your hard drive or on the Dell Support website at support.dell.com or see “Contacting Dell” on page 55 for assistance.

Alert! Previous attempts at booting this system have failed at checkpoint [nnnn]. For help in resolving this problem, please note this checkpoint and contact Dell Technical Support — The computer failed to complete the boot routine three consecutive times for the same error (see “Contacting Dell” on page 55 for assistance).

CMOS checksum error — Possible motherboard failure or RTC battery low. Replace the battery (see the *Service Manual* on the Dell Support website at support.dell.com or see “Contacting Dell” on page 55 for assistance).

CPU fan failure — CPU fan has failed. Replace the CPU fan (see the *Service Manual* on the Dell Support website at support.dell.com).

Hard-disk drive failure — Possible hard disk drive failure during POST (see “Contacting Dell” on page 55 for assistance).

Hard-disk drive read failure — Possible hard disk drive failure during HDD boot test (see “Contacting Dell” on page 55 for assistance).

Keyboard failure — Keyboard failure or loose cable. Replace the keyboard, see the *Service Manual* on the Dell Support website at support.dell.com.

No boot device available — No bootable partition on hard disk drive, the hard disk drive cable is loose, or no bootable device exists.

- If the hard drive is your boot device, ensure that the cables are connected and that the drive is installed properly and partitioned as a boot device.
- Enter system setup and ensure that the boot sequence information is correct (see the *Dell Technology Guide* on the Dell Support website at support.dell.com).

No timer tick interrupt — A chip on the system board might be malfunctioning or motherboard failure (see “Contacting Dell” on page 55 for assistance).

USB over current error — Disconnect the USB device. Your USB device needs more power for it to function properly. Use an external power source to connect the USB device, or if your device has two USB cables, connect both of them.

NOTICE- Hard Drive SELF MONITORING SYSTEM has reported that a parameter has exceeded its normal operating range. Dell recommends that you back up your data regularly. A parameter out of range may or may not indicate a potential hard drive problem — S.M.A.R.T error, possible hard disk drive failure. This feature can be enabled or disabled in the BIOS setup (see “Contacting Dell” on page 55 for assistance).

Hardware Troubleshooter

If a device is either not detected during the operating system setup or is detected but incorrectly configured, you can use the **Hardware Troubleshooter** to resolve the incompatibility.

To start the Hardware Troubleshooter:

1. Click **Start**  → **Help and Support**.
2. Type `hardware troubleshooter` in the search field and press <Enter> to start the search.
3. In the search results, select the option that best describes the problem and follow the remaining troubleshooting steps.

Dell Diagnostics

If you experience a problem with your computer, perform the checks in “Lockups and Software Problems” on page 35 and run the Dell Diagnostics before you contact Dell for technical assistance.

 **NOTE: Dell Diagnostics works only on Dell computers.**

 **NOTE:** The *Drivers and Utilities* disc is optional and may not ship with your computer.

See the *Dell Technology Guide* to review your computer’s configuration information, and ensure that the device that you want to test displays in the system setup program and is active.

Start the Dell Diagnostics from your hard drive or from the *Drivers and Utilities* disc.

Starting Dell Diagnostics From Your Hard Drive

The Dell Diagnostics is located on a hidden diagnostic utility partition on your hard drive.

 **NOTE:** If your computer cannot display a screen image, see “Contacting Dell” on page 55.

1. Ensure that the computer is connected to an electrical outlet that is known to be working properly.
2. Turn on (or restart) your computer.
3. When the DELL™ logo appears, press <F12> immediately. Select **Diagnostics** from the boot menu and press <Enter>.

 **NOTE:** If you wait too long and the operating system logo appears, continue to wait until you see the Microsoft® Windows® desktop; then, shut down your computer and try again.

 **NOTE:** If you see a message stating that no diagnostics utility partition has been found, run the Dell Diagnostics from the *Drivers and Utilities* disc.

4. Press any key to start the Dell Diagnostics from the diagnostics utility partition on your hard drive.
5. When the Dell Diagnostics **Main Menu** appears, select the test you want to run.

Starting Dell Diagnostics From the Drivers and Utilities Disc

 **NOTE:** Your computer does not have an internal optical drive. Use an external optical drive or any external storage device for the procedures that involve discs

1. Insert the *Drivers and Utilities* disc.
2. Shut down and restart the computer.
When the DELL logo appears, press <F12> immediately.

 **NOTE:** If you wait too long and the operating system logo appears, continue to wait until you see the Microsoft® Windows® desktop; then, shut down your computer and try again.

 **NOTE:** The next steps change the boot sequence for one time only. On the next start-up, the computer boots according to the devices specified in the system setup program.

3. When the boot device list appears, highlight **CD/DVD/CD-RW** and press <Enter>.
4. Select the **Boot from CD-ROM** option from the menu that appears and press <Enter>.
5. Type 1 to start the CD menu and press <Enter> to proceed.
6. Select **Run the 32 Bit Dell Diagnostics** from the numbered list. If multiple versions are listed, select the version appropriate for your computer.
7. When the Dell Diagnostics **Main Menu** appears, select the test you want to run.

Restoring Your Operating System

You can restore your operating system in the following ways:

- System Restore returns your computer to an earlier operating state without affecting data files. Use System Restore as the first solution for restoring your operating system and preserving data files.
- Dell Factory Image Restore returns your hard drive to the operating state it was in when you purchased the computer. This procedure permanently deletes all data on the hard drive and removes any programs installed after you received the computer. Use Dell Factory Image Restore only if System Restore did not resolve your operating system problem.
- If you received an Operating System disc with your computer, you can use it to restore your operating system. However, using the Operating System disc also deletes all data on the hard drive. Use the disc only if System Restore did not resolve your operating system problem.



NOTE: Your computer does not have an internal optical drive. Use an external optical drive or any external storage device for the procedures that involve discs.

System Restore

The Windows operating systems provide a System Restore option which allows you to return your computer to an earlier operating state (without affecting data files) if changes to the hardware, software, or other system settings have left the computer in an undesirable operating state. Any changes that System Restore makes to your computer are completely reversible.

 **CAUTION: Make regular backups of your data files. System Restore does not monitor your data files or recover them.**

 **NOTE:** The procedures in this document are applicable for the Windows default view, so they may not apply if you set your Dell™ computer to the Windows Classic view.

Starting System Restore

1. Click **Start** .
2. In the **Start Search** box, type `System Restore` and press <Enter>.

 **NOTE:** The **User Account Control** window may appear. If you are an administrator on the computer, click **Continue**; otherwise, contact your administrator to continue the desired action.

3. Click **Next** and follow the instructions on the screen.

In the event that System Restore did not resolve the issue, you may undo the last system restore.

Undoing the Last System Restore

 **NOTE:** Before you undo the last system restore, save and close all open files and exit any open programs. Do not alter, open, or delete any files or programs until the system restoration is complete.

1. Click **Start** .
2. In the **Start Search** box, type `System Restore` and press <Enter>.
3. Click **Undo my last restoration** and click **Next**.

Dell Factory Image Restore

 **CAUTION:** Using Dell Factory Image Restore permanently deletes all data on the hard drive and removes any programs or drivers installed after you received your computer. If possible, back up the data before using this option. Use Dell Factory Image Restore only if System Restore did not resolve your operating system problem.

 **NOTE:** Dell Factory Image Restore may not be available in certain countries or on certain computers.

Use Dell Factory Image Restore only as the last method to restore your operating system. This option restores your hard drive to the operating state it was in when you purchased the computer. Any programs or files added since you received your computer—including data files—are permanently deleted from the hard drive. Data files include documents, spreadsheets, e-mail messages, digital photos,

Restoring Your Operating System

music files, and so on. If possible, back up all data before using Dell Factory Image Restore.

1. Turn on the computer. When the Dell logo appears, press <F8> several times to access the **Vista Advanced Boot Options** window.

 **NOTE:** If you wait too long and the operating system logo appears, continue to wait until you see the Microsoft® Windows® desktop; then, shut down your computer and try again.

2. Select **Repair Your Computer**.
3. The **System Recovery Options** window appears.
4. Select a keyboard layout and click **Next**.
5. To access the recovery options, log on as a local user. To access the command prompt, type `administrator` in the **User name** field, then click **OK**.

6. Click **Dell Factory Image Restore**. The **Dell Factory Image Restore** welcome screen appears.

 **NOTE:** Depending upon your configuration, you may need to select **Dell Factory Tools**, then **Dell Factory Image Restore**.

7. Click **Next**. The **Confirm Data Deletion** screen appears.

 **NOTE:** If you do not want to proceed with Factory Image Restore, click **Cancel**.

8. Select the checkbox to confirm that you want to continue reformatting the hard drive and restoring the system software to the factory condition, then click **Next**.

The restore process begins and may take five or more minutes to complete. A message appears when the operating system and factory-installed applications have been restored to factory condition.

9. Click **Finish** to reboot the system.

Operating System Reinstallation

Before You Begin

If you are considering reinstalling the Windows operating system to correct a problem with a newly installed driver, first try using Windows Device Driver Rollback. If Device Driver Rollback does not resolve the problem, then use System Restore to return your operating system to the operating state it was in before you installed the new device driver. See “System Restore” on page 44.

 **CAUTION:** Before performing the installation, back up all data files on your primary hard drive. For conventional hard drive configurations, the primary hard drive is the first drive detected by the computer.

To reinstall Windows, you need the following:

- Dell *Operating System* disc
- Dell *Drivers and Utilities* disc

 **NOTE:** The *Drivers and Utilities* disc contains drivers that were installed during the assembly of the computer. Use the Dell Drivers and Utilities disc to load any required drivers. Depending on the region from which you ordered your computer, or whether you requested the disc, the Dell *Drivers and Utilities* disc and *Operating System* disc may not ship with your computer.

Reinstalling Windows Vista

 **NOTE:** Your computer does not have an internal optical drive. Use an external optical drive or any external storage device for the procedures that involve discs.

The reinstallation process can take 1 to 2 hours to complete. After you reinstall the operating system, you must also reinstall the device drivers, virus protection program, and other software.

1. Save and close any open files and exit any open programs.
2. Insert the *Operating System* disc.
3. Click **Exit** if the **Install Windows** message appears.
4. Restart the computer.
5. When the DELL logo appears, press <F12> immediately.

 **NOTE:** If you wait too long and the operating system logo appears, continue to wait until you see the Microsoft® Windows® desktop; then, shut down your computer and try again.

 **NOTE:** The next steps change the boot sequence for one time only. On the next start-up, the computer boots according to the devices specified in the system setup program.

6. When the boot device list appears, highlight **CD/DVD/CD-RW Drive** and press <Enter>.
7. Press any key to **Boot from CD-ROM**. Follow the instructions on the screen to complete the installation.

Getting Help

If you experience a problem with your computer, you can complete the following steps to diagnose and troubleshoot the problem:

1. See “Solving Problems” on page 29 for information and procedures that pertain to the problem your computer is experiencing.
2. See the *Dell Technology Guide* for more troubleshooting information.
3. See “Dell Diagnostics” on page 40 for procedures on how to run Dell Diagnostics.
4. Fill out the “Diagnostic Checklist” on page 54.
5. Use Dell’s extensive suite of online services available at Dell Support (**support.dell.com**) for help with installation and troubleshooting procedures. See “Online Services” on page 51 for a more extensive list of Dell Support online.

6. If the preceding steps have not resolved the problem, see “Before You Call” on page 54.

 **NOTE:** Call Dell Support from a telephone near or at the computer so that the support staff can assist you with any necessary procedures.

 **NOTE:** Dell’s Express Service Code system may not be available in all countries.

When prompted by Dell’s automated telephone system, enter your Express Service Code to route the call directly to the proper support personnel. If you do not have an Express Service Code, open the **Dell Accessories** folder, double-click the **Express Service Code** icon, and follow the directions.

 **NOTE:** Some of the services are not always available in all locations outside the continental U.S. Call your local Dell representative for information on availability.

Technical Support and Customer Service

Dell's support service is available to answer your questions about Dell hardware. Our support staff use computer-based diagnostics to provide fast, accurate answers.

To contact Dell's support service, see "Before You Call" on page 54 and then see the contact information for your region or go to **support.dell.com**.

DellConnect™

DellConnect is a simple online access tool that allows a Dell service and support associate to access your computer through a broadband connection, diagnose your problem and repair it all under your supervision. For more information, go to **www.dell.com/DellConnect**.

Online Services

You can learn about Dell products and services on the following websites:

- www.dell.com
- www.dell.com/ap (Asian/Pacific countries only)
- www.dell.com/jp (Japan only)
- www.euro.dell.com (Europe only)
- www.dell.com/la (Latin American and Caribbean countries)
- www.dell.ca (Canada only)

You can access Dell Support through the following websites and e-mail addresses:

Dell Support websites

- support.dell.com
- support.jp.dell.com (Japan only)
- support.euro.dell.com (Europe only)

Dell Support e-mail addresses

- mobile_support@us.dell.com
- support@us.dell.com
- la-techsupport@dell.com (Latin America and Caribbean countries only)
- apsupport@dell.com (Asian/Pacific countries only)

Dell Marketing and Sales e-mail addresses

- apmarketing@dell.com (Asian/Pacific countries only)
- sales_canada@dell.com (Canada only)

Anonymous file transfer protocol (FTP)

- [ftp.dell.com](ftp://ftp.dell.com)

Log in as user: `anonymous`, and use your e-mail address as your password.

Automated Order-Status Service

To check on the status of any Dell products that you have ordered, you can go to **support.dell.com**, or you can call the automated order-status service. A recording prompts you for the information needed to locate and report on your order. For the telephone number to call your region, see “Contacting Dell” on page 55.

If you have a problem with your order, such as missing parts, wrong parts, or incorrect billing, contact Dell for customer assistance. Have your invoice or packing slip handy when you call. For the telephone number to call for your region, see “Contacting Dell” on page 55.

Product Information

If you need information about additional products available from Dell, or if you would like to place an order, visit the Dell website at **www.dell.com**. For the telephone number to call for your region or to speak to a sales specialist, see “Contacting Dell” on page 55.

Returning Items for Repair Under Warranty or for Credit

Prepare all items being returned, whether for repair or credit, as follows:

-  **NOTE:** Before you return the product to Dell, make sure to back up any data on the hard drive and on any other storage device in the product. Remove any and all confidential, proprietary and personal information, as well as removable media, such as CDs, and PC Cards. Dell is not responsible for any of your confidential, proprietary or personal information; lost or corrupted data; or damaged or lost removable media that may be included with your return.
1. Call Dell to obtain a Return Material Authorization Number, and write it clearly and prominently on the outside of the box.
 2. For the telephone number to call for your region, see “Contacting Dell” on page 55.
 3. Include a copy of the invoice and a letter describing the reason for the return.
 4. Include a copy of the Diagnostics Checklist (see “Diagnostic Checklist” on page 54), indicating the tests that you have run and any error messages reported by the Dell Diagnostics (see “Dell Diagnostics” on page 40).
 5. Include any accessories that belong with the item(s) being returned (power cables, software, guides, and so on) if the return is for credit.
 6. Pack the equipment to be returned in the original (or equivalent) packing materials.

 **NOTE:** You are responsible for paying shipping expenses. You are also responsible for insuring any product returned, and you assume the risk of loss during shipment to Dell. Collect On Delivery (C.O.D.) packages are not accepted.

 **NOTE:** Returns that are missing any of the preceding requirements will be refused at Dell’s receiving dock and returned to you.

Before You Call

 **NOTE:** Have your Express Service Code ready when you call. The code helps Dell's automated-support telephone system direct your call more efficiently. You may also be asked for your Service Tag (located on the back or bottom of your computer).

Remember to fill out the following Diagnostics Checklist. If possible, turn on your computer before you call Dell for assistance and call from a telephone at or near the computer. You may be asked to type some commands at the keyboard, relay detailed information during operations, or try other troubleshooting steps possible only at the computer itself. Ensure that the computer documentation is available.

Diagnostic Checklist

- Name:
- Date:
- Address:
- Phone number:
- Service Tag (bar code on the back or bottom of the computer):
- Express Service Code:
- Return Material Authorization Number (if provided by Dell support technician):
- Operating system and version:
- Devices:
- Expansion cards:
- Are you connected to a network? Yes/No
- Network, version, and network adapter:
- Programs and versions:

See your operating system documentation to determine the contents of the computer's start-up files. If the computer is connected to a printer, print each file. Otherwise, record the contents of each file before calling Dell.

- Error message, beep code, or diagnostic code:
- Description of problem and troubleshooting procedures you performed:

Contacting Dell

For customers in the United States, call 800-WWW-DELL (800-999-3355).

 **NOTE:** If you do not have an active Internet connection, you can find contact information on your purchase invoice, packing slip, bill, or Dell product catalog.

Dell provides several online and telephone-based support and service options. Availability varies by country and product, and some services may not be available in your area.

To contact Dell for sales, technical support, or customer service issues:

1. Visit **support.dell.com**.
2. Verify your country or region in the **Choose A Country/Region** drop-down menu at the bottom of the page.
3. Click **Contact Us** on the left side of the page.
4. Select the appropriate service or support link based on your need.
5. Choose the method of contacting Dell that is convenient for you.

Finding More Information and Resources

If you need to:

reinstall your operating system

run a diagnostic program for your computer, reinstall notebook system software, or update drivers for your computer, and readme files

learn more about your operating system, maintaining peripherals, Internet, Bluetooth[®], networking, and e-mail

upgrade your computer with new or additional memory, or a new hard drive

reinstall or replace a worn or defective part

See:

the Operating System disc

the *Drivers and Utilities* disc



NOTE: Drivers and documentation updates can be found on the Dell™ Support website at **support.dell.com**.

the *Dell Technology Guide* installed on your hard drive

the *Service Manual* on the Dell Support website at **support.dell.com**



NOTE: In some countries, opening and replacing parts of your computer may void your warranty. Check your warranty and return policies before working inside your computer.

If you need to:

find safety best practices information for your computer review Warranty information, Terms and Conditions (U.S. only), Safety instructions, Regulatory information, Ergonomics information, and End User License Agreement

find your Service tag/Express Service Code— You must use the service tag to identify your computer on **support.dell.com** or to contact technical support

find drivers and downloads
access technical support and product help
check on your order status for new purchases
find solutions and answers to common questions
locate information for last-minute updates about technical changes to your computer or advanced technical-reference material for technicians or experienced users

See:

the safety and regulatory documents that shipped with your computer and also see the Regulatory Compliance Homepage at **www.dell.com/regulatory_compliance**

the back or bottom of your computer

the Dell Support website at **support.dell.com**

Specifications

System Model

Inspiron 1320

This section provides information that you may need when setting up, updating drivers for, and upgrading your computer.

-  **NOTE:** Offerings may vary by region. For more information regarding the configuration of your computer, click **Start** → **Help and Support** and select the option to view information about your computer.

Processor

Type	L2 cache
Intel® Core™2 Duo	2 MB/3 MB
Intel Pentium® Dual-Core	1 MB
Intel Celeron® Dual-Core	1 MB
L1 cache	128 KB (Intel-64 KB per core)
External bus frequency:	
Intel Core2 Duo	800 MHz/1066 MHz
Intel Pentium Dual-Core	800 MHz
Intel Celeron Dual-Core	800 MHz

Memory

Connectors	two user-accessible SODIMM connectors
Capacities	1 GB, 2 GB, and 4 GB
Type	800 MHz SODIMM DDR2
Memory configuration possible	1 GB, 2 GB, 3 GB, 4 GB, 6 GB, and 8 GB
Minimum	1 GB (single channel)
Maximum	8 GB (dual channel)



NOTE: Memory specification of greater than 4 GB is not well supported by 32-bit operating systems.

Computer Information

System Chipset	Intel GM45 (UMA) Intel GM45 (Discrete)
Data bus width	64 bits
DRAM bus width	dual channel (2) 64-bit buses
Processor address bus width	32 bits
Flash EPROM	2 MB
Graphics bus	PCI-E X16

Specifications

ExpressCard

Controller	Mobile Intel Express (ICH9m)
Cards supported	ExpressCard/34 (34 mm) 1.5 V and 3.3 V
Connector size	26 pins

Communications

Network adapter	10/100/1000 Ethernet LAN on system board
Wireless	WPAN with Bluetooth® wireless technology, wireless internal WLAN with WiFi bg and WiFi agn

Video

<i>UMA</i>	
Video type	integrated on system board
Video controller	Intel GM45
Video memory	Up to 1292 MB of system shared memory
LCD interface	Low Voltage Differential Signaling (LVDS)
<i>Discrete</i>	
Video type	discrete video card
Video controller	ATI Mobility Radeon™ HD 4330
Video memory	512 MB (64M x 16 x 4 DDR2)
LCD interface	Low Voltage Differential Signaling (LVDS)

Audio

Audio type	IDT 92HD81B High Definition Audio codec with SRS Premium Sound™
Audio controller	IDT 92HD81B
Stereo conversion	24-bit (analog-to-digital and digital-to-analog)
Internal Interface	Intel High Definition Audio
External Interface	microphone-in connector, stereo headphone/speaker connector
Speaker	two 4-ohm speakers
Internal speaker amplifier	1 watt per channel into 4 ohms
Volume controls	software program menus or media control buttons

Ports and Connectors

Audio	one microphone connector, one stereo headphone/speaker connector
IEEE 1394a	4-pin serial connector
Mini-Card	one half size Mini-Card slot
Network adapter	RJ45 connector
eSATA	one seven-pin/four-pin eSATA/USB combo connector with 5V/1.5A output
USB	two 4-pin USB 2.0-compliant connectors
HDMI	19-pin connector
VGA	15-hole connector

Specifications

Display

Type 13.3 inch High Definition
TrueLife

Dimensions:

Height 308.1 mm (12.1 inches)

Width 183.6 mm (7.23 inches)

Diagonal 336.6mm (13.3 inches)

Maximum
resolution 1366 x 768

Refresh rate 60 Hz

Luminance 200 min. 220 typ. cd/m²
(WLED 5 point avg)

Viewing Angles:

Horizontal ±45° (WLED) typ.

Vertical +15°/-35° (WLED) typ.

Pixel pitch 0.2148 mm

Display

Controls brightness can be
controlled through
keyboard shortcuts (see
the *Dell Technology Guide*
for more information)

Keyboard

Number of keys 86/103 (English-U.S.,
Simplified Chinese,
Traditional Chinese, and
Thai)

Layout QWERTY

Camera

Pixel	1.3 megapixel
Video resolution	320 x 240 ~1280 x 1024 (640 x 480 at 30 fps)
Diagonal viewing angle	60° ± 1°

Touch Pad*Resolution:*

X coordinate	1701 DPI
Y coordinate	2540 DPI

Size:

Width	79.62 mm (3.13 inches) sensor-active area
Height	39.51 mm (1.56 inches) rectangle

Battery

Type	4-cell/6-cell smart lithium ion
Depth	51.6 mm (2.03 inches) (4/6 cell)
Height	21.0 mm (0.83 inches) (4/6 cell)
Width	207.7 mm (8.18 inches) (4/6 cell)
Weight	0.26 kg (0.57 lb) (4 cell) 0.34 kg (0.75 lb) (6 cell)
Voltage	14.8 VDC (4 cell) 11.1 VDC (6 cell)
Charge time (approximate):	4 hours (when the computer is turned off)

Specifications

Battery

Operating time	Battery operating time varies depending on operating conditions and can be significantly reduced under certain power-intensive conditions. See the <i>Dell Technology Guide</i> on your hard drive or on the Dell Support website at support.dell.com for more information.
Life span (approximate)	300 discharge/charge cycles
<i>Temperature range:</i>	
Operating	0° to 50°C (32° to 122°F)
Storage	-20° to 60°C (-4° to 140°F)
Coin-cell battery	CR-2032

AC Adapter

Input voltage	100–240 VAC
Input current (maximum)	1.5 A
Input frequency	50–60 Hz
Output power	65 W or 90 W
Rated Output current (90 W)	4.62 A
Rated Output current (65 W)	3.34 A
Rated output voltage	19.5 VDC
<i>Dimensions:</i>	
<i>65 W</i>	
Height	28.0 mm (1.10 inches)/ 16 mm (0.63 inches)
Width	58.0 mm (2.28 inches)/ 66 mm (5.6 inches)

AC Adapter

Depth	137.0 mm (5.39 inches)/ 127 mm (5.0 inches)
Weight (with cables)	0.56 kg (1.23 lb)/0.25 kg (0.55 lb)
<i>90 W</i>	
Height	21 mm (0.83 inches)/ 16 mm (0.63 inches)
Width	70 mm (2.76 inches)/ 65 mm (2.56 inches)
Depth	147 mm (5.79 inches)/ 90 mm (3.54 inches)
Weight (with cables)	0.46 kg (1.01 lb)/0.26 kg (0.57 lb)
Operating	0° to 40°C (32° to 104°F)
Storage	-40° to 70°C (-104° to 158°F)

Physical

Height	27.0 mm to 31.0 mm (1.06 inches to 1.22 inches)
Width	322.0 mm (12.7 inches)
Depth	218.0 mm (8.58 inches)

Weight (with 4-cell battery):

Configurable to less than	1.68 kg (3.74 lb)
------------------------------	-------------------

Computer Environment

Relative humidity (maximum):

Operating	10% to 90% (noncondensing)
Storage	5% to 95% (noncondensing)

Specifications

Computer Environment

Altitude (maximum):

Operating	-15.2 to 3048 m (-50 to 10,000 ft)
Storage	-15.2 to 10,668 m (-50 to 35,000 ft)
Airborne contaminant level	G2 or lower as defined by ISA-S71.04-1985

Temperature range:

Operating	0° to 35°C (32° to 95°F)
Storage	-40° to 65°C (-40° to 149°F)

Computer Environment

Maximum vibration (using a random-vibration spectrum that simulates user environment):

Operating	0.66 GRMS
Non-Operating	1.3 GRMS

Maximum shock (for operating - measured with Dell Diagnostics running on the hard drive and a 2-ms half-sine pulse; for non-operating - measured with hard drive in head-parked position and a 2-ms half-sine pulse):

Operating	110 GRMS
Non-Operating	160 GRMS

Appendix

Macrovision Product Notice

This product incorporates copyright protection technology that is protected by method claims of certain U.S. patents and other intellectual property rights owned by Macrovision Corporation and other rights owners. Use of this copyright protection technology must be authorized by Macrovision Corporation, and is intended for home and other limited viewing uses only unless otherwise authorized by Macrovision Corporation. Reverse engineering or disassembly is prohibited.

Index

A

- AC adapter
 - size and weight **64, 65**
- airflow, allowing **5**

B

- backups
 - creating **28**

C

- calling Dell **54**
- CDs, playing and creating **26**
- chipset **59**
- computer capabilities **26**
- computer, setting up **5**
- conserving energy **27**

- Contacting Dell online **55**
- customer service **50**
- customizing
 - your desktop **26**
 - your energy settings **27**

D

- damage, avoiding **5**
- data, backing up **28**
- Dell Diagnostics **40**
- Dell Factory Image Restore **43**
- Dell Support Center **37**
- Dell support website **57**
- Dell Technology Guide
 - for further information **56**

Diagnostic Checklist **54**
drivers and downloads **57**
DVDs, playing and creating **26**

E

email addresses
 for technical support **51**
energy
 conserving **27**
expansion bus **60**

F

finding more information **56**
FTP login, anonymous **51**

H

hardware problems
 diagnosing **40**

Hardware Troubleshooter **40**
help
 getting assistance and support **49**

I

Internet connection **12**
ISP
 Internet Service Provider **12**

M

memory problems
 solving **34**
memory support **59**

N

network connection
 fixing **31**
network speed
 testing **31**

P

- power problems, solving **32**
- power strips, using **6**
- processor **58**
- products
 - information and purchasing **52**

R

- reinstalling Windows **43**
- resources, finding more **56**
- restoring factory image **45**

S

- setup, before you begin **5**
- shipping products
 - for return or repair **53**
- software features **26**
- software problems **35**

- specifications **56, 58**
- support email addresses **51**
- System Messages **38**
- System Restore **43**

U

- USB PowerShare **15**

V

- ventilation, ensuring **5**

W

- warranty returns **53**
- Windows, reinstalling **43**
- Windows Vista® **9**
 - Program Compatibility Wizard **36**
 - reinstalling **48**
- wired network connection **7**
- wireless network connection **31**



Printed in the U.S.A.

www.dell.com | support.dell.com



0G374RA00